

# MEISTERSATZ®

## O R I G I N A L

### BOMBAS DE AGUA

CATÁLOGO 2018

CONTAMOS CON  
CERTIFICACIÓN  
ISO 9001: 2015



OUR FAMILY  
OF BRANDS



ContiTech

MEISTERSATZ®  
O R I G I N A L



# MEISTERSATZ®

## Definición de Meistersatz

[meis-ter-sats]

Origen: Alemán

**"Refacción, Repuesto, Autoparte o Pieza Maestra de Alta Calidad en su Manufactura"**

Principales países productores:

México, Alemania, España, Italia, Francia, Brasil y China



## Calidad

La marca Meistersatz es reconocida a nivel mundial como la solución en refacciones automotrices con estándares de calidad similares a Equipo Original. Ofrecemos una amplia gama de productos y aplicaciones que cubren los diversos sistemas del vehículo como lo son motor, dirección, suspensión y eléctrico.

La calidad de las refacciones Meistersatz es avalada por los Fabricantes de Autopartes de Equipo Original más reconocidos a nivel mundial.

Por estas razones somos preferidos entre la amplia gama de marcas "Genéricas" por los instaladores quienes buscan una solución económica a sus necesidades de mantenimiento correctivo sin tener que enfrentar dobles cargos por garantías y fallas en la instalación.

Cuando piense en soluciones en la instalación de Refacciones Automotrices, Meistersatz es su opción mas cercana a la Original.

## Categorías

Anti Vibración

Central Eléctrica

Bombas de Dirección Hidráulica y Cremalleras

Kits de Distribución

Juntas y Retenes

Motor y sus Componentes

**Sistema de Refrigeración del Motor**

Suspensión

Transmisión

Misceláneos

Amortiguadores de Cofre y Cajuela

## Distribuido por:

**CRP DE MEXICO SA DE CV**

Ricardo Flores Magón 92  
Bodega 7 - 9 Colonia San Jerónimo  
Caleras Puebla , Puebla. México

Tels: 01 222 2249056

Lada sin costo: 01 800 8382277

E-mail: [mercadotecnia@crpindustries.com](mailto:mercadotecnia@crpindustries.com)

Web: [www.meistersatz.com.mx](http://www.meistersatz.com.mx)

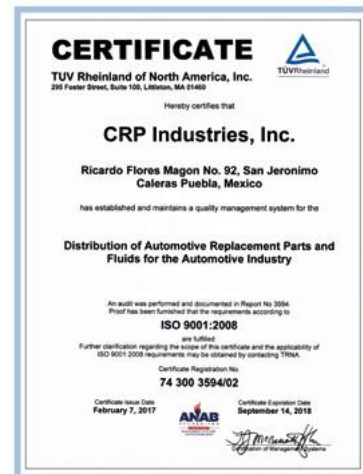

**EMPRESA CERTIFICADA  
ISO 9001: 2015**



CATMX03 Febrero de 2018

Reemplaza

CATMX02 Febrero de 2017

**Nuestro Futuro , Hoy !!!**



**19200P8AA02-LA / CARTER P-2455** BOMBA DE AGUA



<b>ACURA</b>	MDX	2001 - 2002	V6 3.5L
	TL	1999 - 2003	V6 3.2L

INCLUYE O RING

**19200RFE003-LA / CARTER P-9314** BOMBA DE AGUA



<b>ACURA</b>	TSX	2004 - 2006	4 CIL. 2.4L
--------------	-----	-------------	-------------

INCLUYE O RING

**93181118-LA / CARTER P-5092** BOMBA DE AGUA



<b>ALFA ROMEO</b>	159	2007 - 2008	4 CIL. 2.2L
-------------------	-----	-------------	-------------

INCLUYE O RINGS

**022121011A-LA / CARTER P-2142** BOMBA DE AGUA



<b>AUDI</b>	Q7	2007 - 2010	V6 3.6L
-------------	----	-------------	---------

INCLUYE O RING

# BOMBAS DE AGUA



**022121011V-LA / CARTER P-9366** BOMBA DE AGUA



AUDI	A3	2005 - 2008	V6 3.2L IMPULSOR DE 7 ASPAS
	TT	2004 - 2010	V6 3.2L IMPULSOR DE 7 ASPAS

INCLUYE O RING

**03C121005N-LA / CARTER P-2154** BOMBA DE AGUA



AUDI	A1	2011 - 2014	4 CIL. 1.4L TURBO
	A3	2009 - 2013	4 CIL. 1.4L TURBO

INCLUYE O RING

**06A121012E-LA / CARTER P-2030** BOMBA DE AGUA



AUDI	A3	1998 - 2005	4 CIL. 1.8L TURBO
	A4	2000 - 2008	4 CIL. 1.8L TURBO
	S3	2000 - 2005	4 CIL. 1.8L TURBO
	TT	1999 - 2005	4 CIL. 1.8L TURBO

INCLUYE O RING

**06C121004H-LA / CARTER P-9356** BOMBA DE AGUA



AUDI	A4	2002 - 2005	V6 3.0L
	A6	2002 - 2004	V6 3.0L

INCLUYE JUNTA



**06E121005F-LA / CARTER P-2094**

**BOMBA DE AGUA**



AUDI

A4	2005 - 2008	V6 3.2L
A6	2005 - 2008	V6 3.2L
A6	2009 - 2011	V6 3.0L
Q5	2010 - 2012	V6 3.0L DIESEL
Q7	2009 - 2012	V6 3.0L
S4	2010 - 2012	V6 3.0L
S5	2010 - 2011	V6 3.0L

INCLUYE O RING

**06E121005G-LA / CARTER P-2224**

**BOMBA DE AGUA**



AUDI

A4	2009 - 2012	V6 3.2L
A5	2008 - 2011	V6 3.2L
A6	2008 - 2011	V6 2.8L
A6	2009 - 2011	V6 3.2L
Q5	2009 - 2012	V6 3.2L

INCLUYE O RING

**06F121011-LA / CARTER P-1103**

**BOMBA DE AGUA**



AUDI

TT	2010 - 2012	4 CIL. 2.0L TURBO, TFSI
----	-------------	-------------------------

INCLUYE O RING

**06H121026AB-KT1**

**KIT BOMBA DE AGUA**



AUDI

A3	2009 - 2013	4 CIL. 2.0L
A4	2009 - 2013	4 CIL. 2.0L
A5	2013	4 CIL. 2.0L
Q5	2011 - 2012	4 CIL. 2.0L



**06H121026AB-KT2** KIT BOMBA DE AGUA



AUDI	A3	2009 - 2013	4 CIL. 2.0L
	A4	2009 - 2013	4 CIL. 2.0L
	A5	2013	4 CIL. 2.0L
	Q5	2011 - 2012	4 CIL. 2.0L

INCLUYE O RING Y BANDA

**06H121026AF-LA / CARTER P-237** BOMBA DE AGUA



AUDI	A3	2009 - 2013	4 CIL. 2.0L
	A4	2009 - 2013	4 CIL. 2.0L
	A5	2013	4 CIL. 2.0L
	Q5	2011 - 2012	4 CIL. 2.0L

INCLUYE O RING

**077121004M-LA / CARTER P-9340** BOMBA DE AGUA



AUDI	A6	2000 - 2004	V8 4.2L
	A8	2000 - 2007	V8 4.2L
	RS6	2003 - 2004	V8 4.2L

INCLUYE JUNTA

**078121006-LA / CARTER P-2466** BOMBA DE AGUA



AUDI	A4	1997 - 2001	V6 2.8L
	A6	1997 - 2001	V6 2.8L

INCLUYE JUNTA



**079121014D-LA / CARTER P-9324** BOMBA DE AGUA

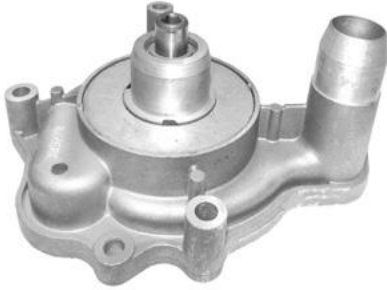

AUDI	A6	2005 - 2008	V8 4.2L
	A8	2004 - 2007	V8 4.2L
	Q7	2007 - 2009	V8 4.2L

INCLUYE O RING

**1K0965561G-FE** BOMBA DE AGUA AUXILIAR



AUDI	A3	2006 - 2008	4 CIL. 2.0L
	A4 QUATTRO	2009	V6 3.2L
	A5	2008 - 2010	V6 3.2L
	A5 QUATTRO	2010	V6 3.2L
	Q5	2009 - 2012	V6 3.2L
	S4	2010 - 2012	V6 3.0L
	TT	2010	4 CIL. 2.0L

INCLUYE O RING

**1K0965561J-FE** BOMBA DE AGUA AUXILIAR



AUDI	A3	2009 - 2013	4 CIL. 2.0
	Q3	2015	4 CIL. 2.0
	TT	2009 - 2015	4 CIL. 2.0

INCLUYE O RING

**11517632426** BOMBA DE AGUA ELECTRICA



BMW	135i	2008 - 2013	6 CIL. 3.0L
	335i	2007 - 2013	6 CIL. 3.0L
	535i	2008 - 2016	6 CIL. 3.0L
	740i	2011 - 2015	6 CIL. 3.0L
	X1	2013 - 2015	6 CIL. 3.0L
	X3	2011 - 2017	6 CIL. 3.0L
	X5	2011 - 2013	6 CIL. 3.0L
	X6	2008 - 2014	6 CIL. 3.0L
	Z4	2012 - 2016	6 CIL. 3.0L



**11511713266-EC** BOMBA DE AGUA

<b>BMW</b>	540I	1999 - 2003	V8 4.4L
	740I	1999 - 2001	V8 4.4L
	740IL	1999 - 2001	V8 4.4L
	X5	2000 - 2003	V8 4.4L

INCLUYE O RING Y JUNTA

**11517503884-LA / CARTER P-2370** BOMBA DE AGUA

<b>BMW</b>	320I	2001 - 2005	6 CIL. 2.2L
	323CI	2000	6 CIL. 2.5L
	323I	1998 - 2000	6 CIL. 2.5L
	323IS	1998 - 1999	6 CIL. 2.5L
	325CI	2001 - 2006	6 CIL. 2.5L
	325I	1992 - 1993	6 CIL. 2.5L
	325XI	2001 - 2005	6 CIL. 2.5L
	328CI	2000	6 CIL. 2.8L
	328I	1996 - 2000	6 CIL. 2.8L
	328IS	1998 - 1999	6 CIL. 2.8L
	330CI	2001 - 2006	6 CIL. 3.0L
	330I	2001 - 2005	6 CIL. 3.0L
	330XI	2001 - 2005	6 CIL. 3.0L
	525I	2001 - 2005	6 CIL. 2.5L
	528I	1997 - 2000	6 CIL. 2.8L
	530I	2001 - 2005	6 CIL. 3.0L
	M3	1994 - 1995	6 CIL. 3.0L
	X3	2004 - 2006	6 CIL. 2.5L
	X3	2004 - 2006	6 CIL. 3.0L
	X5	2001 - 2006	6 CIL. 3.0L
	Z3	1999 - 2002	6 CIL. 2.5L
	Z3	1998 - 2000	6 CIL. 2.8L
	Z3	2001 - 2002	6 CIL. 3.0L
	Z4	2003 - 2005	6 CIL. 2.5L
Z4	2003 - 2005	6 CIL. 3.0L	

INCLUYE O RING



**11517524551-EC** BOMBA DE AGUA



**BMW**

545I	2004 - 2005	V8 4.4L
645CI	2004 - 2005	V8 4.4L
745I	2004 - 2005	V8 4.4L
745LI	2004 - 2005	V8 4.4L
X5	2004 - 2006	V8 4.4L
X5	2004 - 2006	V8 4.8L

INCLUYE JUNTAS

**11517586925-EC** BOMBA DE AGUA ELECTRICA

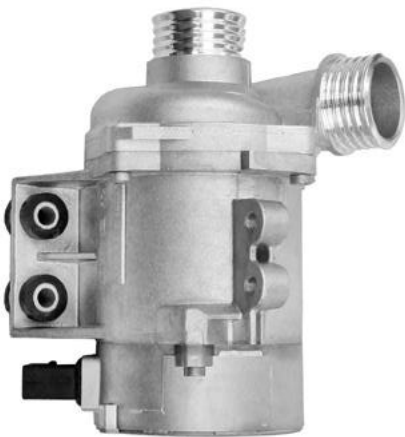

**BMW**

128I	2008-2013	6 CIL. 3.0L
323I	2011-2006	6 CIL. 2.5L
325I	2006	6 CIL. 3.0L
325XI	2006	6 CIL. 3.0L
328I	2007-2013	6 CIL. 3.0L
330I	2006	6 CIL. 3.0L
330XI	2006	6 CIL. 3.0L
525I	2006-2007	6 CIL. 3.0L
525XI	2006-2007	6 CIL. 3.0L
528I	2008-2010	6 CIL. 3.0L
530I	2006-2007	6 CIL. 3.0L
530XI	2006-2007	6 CIL. 3.0L
X3	2007-2010	6 CIL. 3.0L
X5	2007-2010	6 CIL. 3.0L
Z4	2006-2011	6 CIL. 3.0L

**11517838118-EC** BOMBA DE AGUA



**BMW**

M3	2001 - 2006	6 CIL. 3.2L
----	-------------	-------------

INCLUYE O RING Y JUNTA

# BOMBAS DE AGUA



**64116988960-FE** BOMBA DE AGUA AUXILIAR



<b>BMW</b>	525I	2004 - 2005	6 CIL. 2.5L
	530I	2004 - 2005	6 CIL. 3.0L
	545I	2004 - 2005	V8 4.4L
	550I	2006 - 2010	V8 4.8L
	645CI	2004 - 2005	V8 4.4L
	650I	2006 - 2010	V8 4.8L

INCLUYE JUNTAS

**10048949-LA / CARTER P-864** BOMBA DE AGUA



<b>BUICK</b>	CENTURY	1994 - 1997	V6 3.1L
--------------	---------	-------------	---------

INCLUYE JUNTA

**12618472-LA / CARTER P-9361** BOMBA DE AGUA



<b>BUICK</b>	ENCLAVE	2010 - 2014	V6 3.6L
	LACROSSE	2010 - 2014	V6 3.6L

INCLUYE JUNTA

**12532528-LA / CARTER P-968** BOMBA DE AGUA



<b>CADILLAC</b>	ESCALADE	1999 - 2000	V8 5.7L
-----------------	----------	-------------	---------

INCLUYE JUNTAS



**12618472-LA / CARTER P-9361**

**BOMBA DE AGUA**



**CADILLAC**

CTS	2004 - 2012	V6 3.6L
SRX	2010 - 2011	V6 3.0L
SRX	2004 - 2006	V6 3.6L
SRX	2012 - 2014	V6 3.6L
STS	2006 - 2010	V6 3.6L

INCLUYE JUNTA

**90543277-LA / CARTER P-9107**

**BOMBA DE AGUA**



**CADILLAC**

CATERA	1997 - 2001	V6 3.0L
CTS	2003	V6 3.2L

INCLUYE O RING

**10048917-LA / CARTER P-665**

**BOMBA DE AGUA**



**CHEVROLET**

ASTRO	1985 - 1986	V6 4.3L
BLAZER	1987	V8 5.0L
BLAZER	1987 - 1988	V8 5.7L
CAMARO	1987	V8 5.7L
CAMARO	1977 - 1987	V8 5.0L
CAMARO	1980 - 1981	V6 3.8L
CAMARO	1980 - 1981	V8 4.4L
CHEYENNE	1983 - 1987	V8 5.7L
IMPALA	1977 - 1985	V8 5.0L
IMPALA	1977 - 1985	V8 5.7L
IMPALA	1980 - 1982	V8 4.4L
IMPALA	1980 - 1984	V6 3.8L
MICROBUS	1987 - 1991	V8 5.7L
SUBURBAN	1982 - 1988	V8 5.7L

INCLUYE JUNTAS

# BOMBAS DE AGUA



**10048949-LA / CARTER P-864** BOMBA DE AGUA



<b>CHEVROLET</b>	CAVALIER	1990 - 1994	V6 3.1L
	CUTLASS	1995 - 1998	V6 3.1L
	IMPALA	2000 - 2005	V6 3.4L
	LUMINA	1996 - 1998	V6 3.1L
	LUMINA	1995 - 1997	V6 3.4L
	MALIBU	1997 - 2003	V6 3.1L
	MALIBU	2004 - 2005	V6 3.5L
	VENTURE	1997 - 2004	V6 3.4L

INCLUYE JUNTA

**12518443-LA / CARTER P-860** BOMBA DE AGUA



<b>CHEVROLET</b>	CAVALIER	1992 - 1997	4 CIL. 2.2L
	S-10	1994 - 2003	4 CIL. 2.2L

INCLUYE JUNTA

**12522031-LA / CARTER P-910** BOMBA DE AGUA



<b>CHEVROLET</b>	BLAZER	1995	V6 4.3L
	CAMARO	1992	V8 5.0L
	CAMARO	1992	V8 5.7L
	S-10	1994 - 1995	V6 4.3L
	SUBURBAN	1989 - 1995	V8 5.7L

INCLUYE JUNTAS

**12532528-LA / CARTER P-968** BOMBA DE AGUA



<b>CHEVROLET</b>	400SS	1997 - 2004	V8 5.7L
	BLAZER	1996 - 2004	V6 4.3L
	C-1500	1999	V8 5.7L
	C-2500	1999	V8 5.7L
	C-3500	1999	V8 5.7L
	CHEYENNE	1999	V8 5.7L
	EXPRESS	1999 - 2002	V8 5.0L

INCLUYE JUNTAS



**12532528-LA / CARTER P-968**

BOMBA DE AGUA



CHEVROLET

EXPRESS	2007 - 2009	V6 4.3L
MICROBUS	1996 - 2005	V8 5.7L
P-30	2001 - 2002	V8 5.7L
SILVERADO	1997 - 1999	V8 5.7L
SILVERADO	1999 - 2006	V6 4.3L
SONORA	2000 - 2002	V8 5.7L
SUBURBAN	1996 - 2000	V8 5.7L

INCLUYE JUNTAS

**12618472-LA / CARTER P-9361**

BOMBA DE AGUA



CHEVROLET

CAMARO	2010 - 2014	V6 3.6L
CAPTIVA	2012	V6 3.0L <small>SPORT</small>
MALIBU	2008 - 2012	V6 3.6L
TRAVERSE	2009 - 2014	V6 3.6L

INCLUYE JUNTA

**19179031-LA / CARTER P-2093**

BOMBA DE AGUA



CHEVROLET

EQUINOX	2005 - 2010	V6 3.4L
---------	-------------	---------

INCLUYE JUNTA

**24405895-LA / CARTER P-1700**

BOMBA DE AGUA



CHEVROLET

CRUZE	2010 - 2012	4 CIL. 1.8L
SONIC	2012	4 CIL. 1.8L
TRAX	2012 - 2013	4 CIL. 1.8L

INCLUYE O RING



**89017757-LA / CARTER P-2061** BOMBA DE AGUA



**CHEVROLET**

MALIBU	2006 - 2009	V6 3.5L
UPLANDER	2007 - 2009	V6 3.5L

INCLUYE JUNTA

**90392901-LA / CARTER P-2364** BOMBA DE AGUA



**CHEVROLET**

CHEVY	2010 - 2012	4 CIL. 1.6L
CHEVY C2	2004 - 2008	4 CIL. 1.6L
CHEVY C2	2004 - 2009	4 CIL. 1.6L
CHEVY JOY	1995	4 CIL. 1.4L
CHEVY JOY	1994 - 2003	4 CIL. 1.6L
CHEVY MILENIO	1994 - 2000	4 CIL. 1.6L
CHEVY MONZA	1996 - 2002	4 CIL. 1.6L
CHEVY PICKUP	2000 - 2006	4 CIL. 1.6L
CHEVY POP	1994 - 2000	4 CIL. 1.4L
CHEVY POP	1994 - 2003	4 CIL. 1.6L
CHEVY STATION	1996 - 2000	4 CIL. 1.6L
CHEVY SWING	1997 - 2003	4 CIL. 1.6L

INCLUYE O RING

**90543935-LA / CARTER P-1642** BOMBA DE AGUA



**CHEVROLET**

ASTRA	2000 - 2003	4 CIL. 1.8L POLEA CON 23 DIENTES
MERIVA	2007 - 2008	4 CIL. 1.8L POLEA CON 23 DIENTES
ZAFIRA	2000 - 2003	4 CIL. 1.8L POLEA CON 23 DIENTES

INCLUYE O RING



**93181118-LA / CARTER P-5092** BOMBA DE AGUA



<b>CHEVROLET</b>	CAPTIVA	2009	4 CIL. 2.4L
	CAPTIVA SPORT	2012 - 2015	4 CIL. 2.4L
	CAVALIER	2002 - 2005	4 CIL. 2.2L
	HHR	2006 - 2011	4 CIL. 2.4L
	MALIBU	2004 - 2005	4 CIL. 2.2L
	VECTRA	2003 - 2006	4 CIL. 2.2L
	ZAFIRA	2002 - 2006	4 CIL. 2.2L

INCLUYE O RINGS

**93284724-LA / CARTER P-1447** BOMBA DE AGUA



<b>CHEVROLET</b>	ASTRA	2000 - 2003	4 CIL. 2.2L
	ASTRA	2004 - 2006	4 CIL. 2.4L
	LUV	1999 - 2005	4 CIL. 2.2L
	OPTRA	2006 - 2010	4 CIL. 2.0L

INCLUYE O RING

**93284725-LA / CARTER P-1448** BOMBA DE AGUA



<b>CHEVROLET</b>	ASTRA	2004 - 2008	4 CIL. 2.0L POLEA CON 25 DIENTES
------------------	-------	-------------	----------------------------------

INCLUYE O RING

**93385844-LA / CARTER P-1619** BOMBA DE AGUA



<b>CHEVROLET</b>	CORSA	2003 - 2008	4 CIL. 1.8L POLEA CON 19 DIENTES
	MERIVA	2004 - 2006	4 CIL. 1.8L POLEA CON 19 DIENTES
	TORNADO	2003 - 2012	4 CIL. 1.8L POLEA CON 19 DIENTES

INCLUYE O RING

# BOMBAS DE AGUA



<b>96416294-LA / CARTER P-451</b>		<b>BOMBA DE AGUA</b>	
	<b>CHEVROLET</b>	<b>SPARK</b>	<b>2011 - 2015</b>
		<b>4 CIL. 1.2L</b>	
INCLUYE JUNTA			

<b>9666219-LA / CARTER P-1646</b>		<b>BOMBA DE AGUA</b>	
	<b>CHEVROLET</b>	<b>MATIZ</b>	<b>2010 - 2012</b>
		<b>4 CIL. 1.0L</b>	
INCLUYE JUNTA			

<b>96872702-LA / CARTER P-1633</b>		<b>BOMBA DE AGUA</b>	
	<b>CHEVROLET</b>	<b>AVEO</b>	<b>2007 - 2014</b>
		<b>4 CIL. 1.6L</b>	
INCLUYE O RING			

<b>1122001501-EC / CARTER P-9243</b>		<b>BOMBA DE AGUA</b>	
	<b>CHRYSLER</b>	<b>CROSSFIRE</b>	<b>2004 - 2008</b>
		<b>V6 3.2L</b>	
INCLUYE O RING			



**4483453-LA / CARTER P-898** BOMBA DE AGUA



<b>CHRYSLER</b>	LEBARON	1990	4 CIL. 2.2L
	LEBARON	1990 - 1994	4 CIL. 2.5L

INCLUYE O RINGS

**4648952AE-LA / CARTER P-2156** BOMBA DE AGUA



<b>CHRYSLER</b>	TOWN & COUNTRY	2008 - 2010	V6 3.3L
	TOWN & COUNTRY	2008 - 2010	V6 3.8L
	VOYAGER	2008 - 2010	V6 3.3L
	VOYAGER	2008 - 2010	V6 3.8L

INCLUYE JUNTA

**4694307AC-LA / CARTER P-2422** BOMBA DE AGUA



<b>CHRYSLER</b>	CIRRUS	1995 - 2001	4 CIL. 2.4L
	PT CRUISER	2001 - 2010	4 CIL. 2.4L SIN TURBO
	SEBRING	1997 - 2000	4 CIL. 2.4L

INCLUYE O RING

**4781157AA-LA / CARTER P-7165** BOMBA DE AGUA



<b>CHRYSLER</b>	TOWN & COUNTRY	2001 - 2006	V6 3.8L
	VOYAGER	2001 - 2007	V6 3.3L

INCLUYE O RING

# BOMBAS DE AGUA



**4792838AA-LA / CARTER P-9377** BOMBA DE AGUA



<b>CHRYSLER</b>	300C	2005 - 2008	V8 5.7L
	300C	2005 - 2006	V8 6.1L

INCLUYE O RING

**4792968AD-LA / CARTER P-1107** BOMBA DE AGUA



<b>CHRYSLER</b>	300	2006 - 2010	V6 3.5L
	PACIFICA	2005 - 2006	V6 3.5L
	TOWN & COUNTRY	2008 - 2010	V6 4.0L

INCLUYE O RING

**5010898AA-LA / CARTER P-897** BOMBA DE AGUA



<b>CHRYSLER</b>	GRAND VOYAGER	1993 - 2000	V6 3.3L
	GRAND VOYAGER	1993 - 2000	V6 3.8L
	TOWN & COUNTRY	1998 - 2000	V6 3.8L
	VOYAGER	1993 - 2000	V6 3.3L
	VOYAGER	1998 - 2000	V6 3.8L

INCLUYE O RING

**5047138AB-LA / CARTER P-1982** BOMBA DE AGUA



<b>CHRYSLER</b>	200	2012 - 2014	4 CIL. 2.4L
-----------------	-----	-------------	-------------

INCLUYE JUNTA



**5184498AD-LA / CARTER P-2408** BOMBA DE AGUA



**CHRYSLER**

TOWN & COUNTRY	2011 - 2014	V6 3.6L
----------------	-------------	---------

INCLUYE JUNTA

**53011380AG-LA / CARTER P-9303** BOMBA DE AGUA



**CHRYSLER**

ASPEN	2007 - 2008	V8 5.7L
-------	-------------	---------

INCLUYE O RING

**MD997244-LA / CARTER P-911** BOMBA DE AGUA

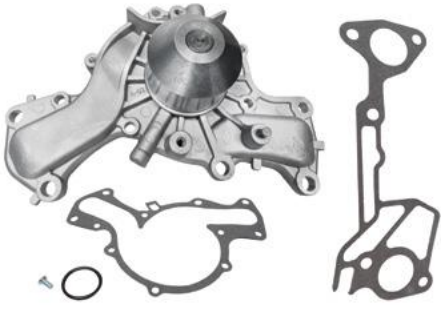

**CHRYSLER**

GRAND VOYAGER	1999 - 2000	V6 3.0L
LEBARON	1990 - 1995	V6 3.0L
VOYAGER	1999 - 2000	V6 3.0L

INCLUYE JUNTAS Y O RING

**04892713AB-EC** BOMBA DE AGUA



**DODGE**

DART	2013 - 2015	4 CIL. 1.4L
------	-------------	-------------

# BOMBAS DE AGUA



**4483453-LA / CARTER P-898** BOMBA DE AGUA



<b>DODGE</b>	CARAVAN	1990 - 1995	4 CIL. 2.5L
	DAKOTA	1990 - 1995	4 CIL. 2.5L
	SHADOW	1990	4 CIL. 2.2L
	SHADOW	1990 - 1994	4 CIL. 2.5L
	SPIRIT	1990 - 1995	4 CIL. 2.5L

INCLUYE O RINGS

**4626054-LA / CARTER P-932** BOMBA DE AGUA



<b>DODGE</b>	DAKOTA	1996 - 1998	4 CIL. 2.5L
--------------	--------	-------------	-------------

INCLUYE JUNTA

**4648952AE-LA / CARTER P-2156** BOMBA DE AGUA



<b>DODGE</b>	GRAND CARAVAN	2008 - 2010	V6 3.3L
	GRAND CARAVAN	2008 - 2010	V6 3.8L

INCLUYE JUNTA

**4667660-LA / CARTER P-996** BOMBA DE AGUA



<b>DODGE</b>	NEON	1995 - 2005	4 CIL. 2.0L 16 VÁLVULAS
	STRATUS	1997 - 2000	4 CIL. 2.0L 16 VÁLVULAS

INCLUYE O RING



**4694307AC-LA / CARTER P-2422** BOMBA DE AGUA



**DODGE**

STRATUS	1995 - 2006	4 CIL. 2.4L TENSOR MECANICO
---------	-------------	-----------------------------

INCLUYE O RING

**4781157AA-LA / CARTER P-7165** BOMBA DE AGUA



**DODGE**

CARAVAN	2001 - 2005	V6 3.3L
---------	-------------	---------

INCLUYE O RING

**4792838AA-LA / CARTER P-9377** BOMBA DE AGUA



**DODGE**

CHALLENGER	2009 - 2010	V8 5.7L
CHALLENGER	2008 - 2010	V8 6.1L
CHARGER	2006 - 2008	V8 5.7L
CHARGER	2006 - 2010	V8 6.1L

INCLUYE O RING

**4792968AD-LA / CARTER P-1107** BOMBA DE AGUA



**DODGE**

AVENGER	2008 - 2010	V6 3.5L
CHARGER	2006 - 2010	V6 3.5L
JOURNEY	2010	V6 3.5L
NITRO	2007 - 2009	V6 4.0L

INCLUYE O RING

# BOMBAS DE AGUA



**5010898AA-LA / CARTER P-897** BOMBA DE AGUA



**DODGE**

CARAVAN	1993 - 2000	V6 3.3L
---------	-------------	---------

INCLUYE O RING

**5047138AB-LA / CARTER P-1982** BOMBA DE AGUA



**DODGE**

AVENGER	2008 - 2014	4 CIL. 2.4L
CALIBER	2007	4 CIL. 1.8L
CALIBER	2007	4 CIL. 2.0L
CALIBER	2007 - 2011	4 CIL. 2.4L
JOURNEY	2010 - 2014	4 CIL. 2.4L

INCLUYE JUNTA

**5184498AD-LA / CARTER P-2408** BOMBA DE AGUA



**DODGE**

CHARGER	2011 - 2014	V6 3.6L
DURANGO	2011 - 2014	V6 3.6L
JOURNEY	2011 - 2014	V6 3.6L

INCLUYE JUNTA

**53011380AG-LA / CARTER P-9303** BOMBA DE AGUA



**DODGE**

DURANGO	2004 - 2008	V8 5.7L
RAM S. PICKUP	2003 - 2008	V8 5.7L <sup>2500</sup>
RAM S. PICKUP	2008	V8 5.7L <sup>3500</sup>

INCLUYE O RING



**53020280-LA / CARTER P-951**

**BOMBA DE AGUA**



**DODGE**

DAKOTA	1993 - 2003	V6 3.9L
DAKOTA	1993 - 1999	V8 5.2L
DAKOTA	1998 - 2003	V8 5.9L
DURANGO	1998 - 1999	V6 3.9L
DURANGO	1998 - 2000	V8 5.2L
DURANGO	1998 - 2003	V8 5.9L
RAM 1500	1994 - 2001	V6 3.9L
RAM 2500	2001 - 2002	V8 5.9L
RAM 3500	1997 - 2002	V8 5.9L
RAM VAN 1500	1999 - 2003	V6 3.9L
RAM VAN 2500	1999 - 2003	V8 5.2L
RAM VAN 3500	1999 - 2003	V8 5.9L
RAMCHARGER	1993	V8 5.2L
RAMCHARGER	1993	V8 5.9L

INCLUYE JUNTA

**53021187AA-LA / CARTER P-927**

**BOMBA DE AGUA**



**DODGE**

DAKOTA	2008 - 2010	V6 3.7L
DURANGO	2000 - 2009	V8 4.7L
RAM 1500	2002 - 2005	V6 3.7L
RAM 2500	2002 - 2005	V8 4.7L

INCLUYE O RING

**MD997244-LA / CARTER P-911**

**BOMBA DE AGUA**

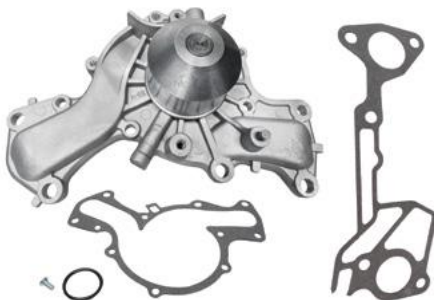

**DODGE**

CARAVAN	1989 - 2000	V6 3.0L
GRAND CARAVAN	1992 - 2000	V6 3.0L
SPIRIT	1990 - 1995	V6 3.0L

INCLUYE JUNTAS Y O RING

# BOMBAS DE AGUA



**04892713AB-EC** BOMBA DE AGUA



FIAT	500	2012 - 2015	4 CIL. 1.4L
	500L	2014 - 2015	4 CIL. 1.4L

**93385844-LA / CARTER P-1619** BOMBA DE AGUA



FIAT	ALBEA	2009 - 2010	4 CIL. 1.8L POLEA CON 19 DIENTES
	IDEA	2008	4 CIL. 1.8L POLEA CON 19 DIENTES

INCLUYE O RING

**1020538-LA / CARTER P-547** BOMBA DE AGUA



FORD	IKON	1998 - 2002	4 CIL. 1.4L 16 VALVULAS
	KA	1998 - 2002	4 CIL. 1.4L 16 VALVULAS

INCLUYE JUNTA

**1020567-LA / CARTER P-545** BOMBA DE AGUA



FORD	FIESTA	1998 - 2001	4 CIL. 1.3L
	IKON	1998 - 2000	4 CIL. 1.3L
	KA	1998 - 2000	4 CIL. 1.3L

INCLUYE JUNTA



**1S7Z-8501AK-LA / CARTER P-2120**

BOMBA DE AGUA



FORD

ESCAPE	2005 - 2008	4 CIL. 2.3L
ESCAPE	2009 - 2014	4 CIL. 2.5L
FOCUS	2005 - 2012	4 CIL. 2.0L
FUSION	2007 - 2009	4 CIL. 2.3L
FUSION	2010 - 2013	4 CIL. 2.5L
RANGER	2001 - 2011	4 CIL. 2.3L

**2STZ8501BG-LA / CARTER P-9320**

BOMBA DE AGUA



FORD

ESCAPE	2004 - 2006	V6 3.0L
FUSION	2006 - 2007	4 CIL. 3.0L
TAURUS	2004 - 2005	V6 3.0L

INCLUYE JUNTA

**7S7G8505A2A-LA / CARTER P-157**

BOMBA DE AGUA



FORD

FIESTA	2011 - 2014	4 CIL. 1.6L
--------	-------------	-------------

INCLUYE JUNTA

**7T4Z8501B-LA / CARTER P-1983**

BOMBA DE AGUA



FORD

EDGE	2007 - 2010	V6 3.5L
FUSION	2010 - 2012	V6 3.5L

INCLUYE O RING



**BR3Z8501H-LA / CARTER P-2415** BOMBA DE AGUA



<b>FORD</b>	F-150	2011 - 2013	V8 5.0L
	<small>INCLUYE O RING</small>		

**D0AZ-8501F-LA / CARTER P-548** BOMBA DE AGUA



<b>FORD</b>	BRONCO	1980 - 1986	V8 5.0L
	BRONCO	1980 - 1987	V8 5.8L
	CLUB WAGON	1995 - 1996	V8 5.8L
	E SERIES VAN	1975 - 1986	V8 5.0L
	F-100 PICKUP	1969 - 1983	V8 5.0L
	F-100 PICKUP	1977 - 1981	V8 5.8L
	F-100 PICKUP	1981 - 1982	V8 4.2L
	F-150 PICKUP	1975 - 1992	V8 5.0L
	F-150 PICKUP	1977 - 1992	V8 5.8L
	F-200 PICKUP	1976 - 1991	V8 5.0L
	F-200 PICKUP	1976 - 1991	V8 5.8L
	F-250 PICKUP	1992 - 1996	V8 5.0L
	F-250 PICKUP	1992 - 1996	V8 5.8L
	F-350 PICKUP	1963 - 1994	V8 5.0L
	F-350 PICKUP	1963 - 1994	V8 5.8L
MICROBUS AYCO	1990 - 1997	V8 5.0L	
MICROBUS CASA VAN	1990 - 1997	V8 5.0L	
MICROBUS EUROCAR	1990 - 1997	V8 5.0L	
MUSTANG	1970 - 1978	V8 5.0L	
MUSTANG	1970 - 1978	V8 5.8L	
<small>INCLUYE JUNTAS</small>			

**F4DZ8501A-LA / CARTER P-960** BOMBA DE AGUA



<b>FORD</b>	SABLE	1994 - 1995	V6 3.8L
	TAURUS	1994 - 1995	V6 3.8L
	WINDSTAR	1995	V6 3.8L
<small>INCLUYE JUNTA Y O RINGS</small>			



**F5T28501C-LA / CARTER P-909** BOMBA DE AGUA



<b>FORD</b>	AEROSTAR	1990 - 1997	V6 4.0L
	EXPLORER	1991 - 2000	V6 4.0L <small>CON VÁLVULAS SOBRE LA CABEZA</small>
	RANGER	1990 - 2000	V6 4.0L

INCLUYE JUNTA

**F63Z8501AA-LA / CARTER P-959** BOMBA DE AGUA



<b>FORD</b>	CONTOUR	1995 - 2000	V6 2.5L
	ESCAPE	2001 - 2003	V6 3.0L
	MONDEO	2001 - 2007	V6 2.5L
	MYSTIQUE	1995 - 2000	V6 2.5L
	SABLE	2001 - 2004	V6 3.0L
	TAURUS	2001 - 2003	V6 3.0L

INCLUYE JUNTA

**F65Z8501AC-LA / CARTER P-979** BOMBA DE AGUA



<b>FORD</b>	CLUB WAGON	1997 - 2000	V6 4.2L
	ECONOLINE W.	1997 - 2003	V6 4.2L
	F150 PICKUP	1998 - 2010	V6 4.2L
	FREESTAR	2004 - 2007	V6 4.2L

INCLUYE JUNTA

**F65Z8501BA-LA / CARTER P-992** BOMBA DE AGUA



<b>FORD</b>	E SERIES VAN	1997 - 2002	V8 4.6L
	E SERIES VAN	1997 - 2002	V8 5.4L
	EXPEDITION	1997 - 2002	V8 4.6L
	EXPEDITION	1997 - 2002	V8 5.4L
	F-150 PICKUP	1997 - 2002	V8 4.6L

INCLUYE O RING

# BOMBAS DE AGUA



**F65Z8501BA-LA / CARTER P-992** BOMBA DE AGUA



**FORD**

F-150 PICKUP	1997 - 2002	V8 5.4L
F-250 PICKUP	1999 - 2002	V8 4.6L
F-250 PICKUP	1999 - 2002	V8 5.4L
LOBO	1997 - 2002	V8 4.6L
LOBO	2001 - 2002	V8 5.4L
S. DUTY PICKUP	1999 - 2002	V8 5.4L

INCLUYE O RING

**F68Z8501A-LA / CARTER P-982** BOMBA DE AGUA



**FORD**

WINDSTAR	1996 - 2005	V6 3.8L
----------	-------------	---------

INCLUYE O RINGS Y JUNTA

**F77Z8501AD-LA / CARTER P-965** BOMBA DE AGUA



**FORD**

EXPLORER	1997 - 2010	V6 4.0L <small>MOTOR CON 1 ÁRBOL DE LEVAS</small>
MUSTANG	2005 - 2010	V6 4.0L
RANGER	2001 - 2011	V6 4.0L

INCLUYE JUNTA

**F8RZ-8501EN-LA / CARTER P-994** BOMBA DE AGUA



**FORD**

CONTOUR	1998 - 2000	4 CIL. 2.0L
ESCAPE	2001 - 2004	4 CIL. 2.0L
ESCORT	1998 - 2003	4 CIL. 2.0L
FOCUS	2000 - 2004	4 CIL. 2.0L <small>DOHC</small>

INCLUYE O RING



**M2S6G8591AA- LA / CARTER P-546**

BOMBA DE AGUA



FORD

COURIER	2001 - 2010	4 CIL. 1.6L
FIESTA	2003 - 2010	4 CIL. 1.6L
FIESTA IKON	2002 - 2004	4 CIL. 1.6L
IKON	2004 - 2007	4 CIL. 1.6L
KA	2001 - 2008	4 CIL. 1.6L

INCLUYE JUNTA

**YS4Z-8501AA-LA / CARTER P-4123**

BOMBA DE AGUA



FORD

FOCUS	2000 - 2004	4 CIL. 2.0L SOHC
-------	-------------	------------------

INCLUYE JUNTA

**12518443-LA / CARTER P-860**

BOMBA DE AGUA



GMC

SONOMA	1994 - 2000	4 CIL. 2.2L
--------	-------------	-------------

INCLUYE JUNTA

**12522031-LA / CARTER P-910**

BOMBA DE AGUA



GMC

SAVANA	1996	V6 4.3L
SAVANA	1996	V8 5.7L
SONOMA	1991 - 1995	V6 4.3L

INCLUYE JUNTAS

# BOMBAS DE AGUA



**12618472-LA / CARTER P-9361** BOMBA DE AGUA



GMC	ACADIA	2007 - 2014	V6 3.6L
	TERRAIN	2012	V6 3.0L
	TERRAIN	2013 - 2014	V6 3.6L

INCLUYE JUNTA

**19200P2AA01-LA / CARTER P-2459** BOMBA DE AGUA



HONDA	CIVIC	1997 - 2000	4 CIL. 1.6L
-------	-------	-------------	-------------

INCLUYE O RING

**19200P8AA02-LA / CARTER P-2455** BOMBA DE AGUA



HONDA	ACCORD	1998 - 2003	V6 3.0L
	ODYSSEY	2001 - 2004	V6 3.5L
	PILOT	2003 - 2005	V6 3.5L

INCLUYE O RING

**19200-RB0-003- LA / CARTER P-2280** BOMBA DE AGUA



HONDA	CITY	2009 - 2012	4 CIL. 1.5L
	FIT	2009 - 2013	4 CIL. 1.5L

INCLUYE O RING



**19200RFE003-LA / CARTER P-9314** BOMBA DE AGUA



<b>HONDA</b>	CIVIC	2002 - 2005	4 CIL. 2.0L
	CR-V	2002 - 2009	4 CIL. 2.4L

INCLUYE O RING

**19200-RNAA02- LA / CARTER P-2058** BOMBA DE AGUA



<b>HONDA</b>	CIVIC	2006 - 2011	4 CIL. 1.8L
--------------	-------	-------------	-------------

INCLUYE O RING

**2510002577-LA / CARTER P-1101** BOMBA DE AGUA



<b>HYUNDAI</b>	I10	2011 - 2012	4 CIL. 1.1L
----------------	-----	-------------	-------------

INCLUYE JUNTA

**2510012501-LA / CARTER P-972** BOMBA DE AGUA



<b>HYUNDAI</b>	ATOS	2000 - 2004	4 CIL. 1.0L
	ATOS	2005 - 2010	4 CIL. 1.1L

INCLUYE JUNTA

# BOMBAS DE AGUA



**2510026902-LA / CARTER P-9139** BOMBA DE AGUA



HYUNDAI	ATTITUDE	2008 - 2010	4 CIL. 1.4L
	ATTITUDE	2006 - 2012	4 CIL. 1.6L
	VERNA	2005 - 2006	4 CIL. 1.6L

INCLUYE JUNTA

**2510042541-LA / CARTER P-2171** BOMBA DE AGUA



HYUNDAI	H100	2006 - 2011	4 CIL. 2.5L DIESEL
---------	------	-------------	--------------------

INCLUYE JUNTAS

**MD997244-LA / CARTER P-911** BOMBA DE AGUA

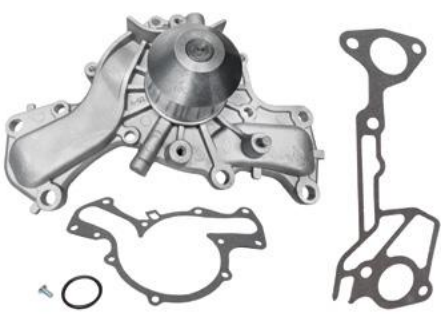

HYUNDAI	SONATA	1990 - 1998	V6 3.0L
---------	--------	-------------	---------

INCLUYE JUNTAS Y O RING

**210107Y025-LA / CARTER P-9276** BOMBA DE AGUA



INFINITI	FX35	2004 - 2005	V6 3.5L
	G35	2003 - 2004	V6 3.5L
	I35	2002 - 2004	V6 3.5L

INCLUYE O RING



**12532528-LA / CARTER P-968**

BOMBA DE AGUA



ISUZU

HOMBRE	1997 - 2000	V6 4.3L
--------	-------------	---------

INCLUYE JUNTAS

**C2C6517-FE**

BOMBA DE AGUA AUXILIAR



JAGUAR

S-TYPE	2003 - 2008	V8 4.2L
XF	2009 - 2010	V8 4.2L
XJ8	2004 - 2009	V8 4.2L
XJR	2004 - 2009	V8 4.2L

**F63Z8501AA-LA / CARTER P-959**

BOMBA DE AGUA



JAGUAR

X-TYPE	2001 - 2008	V6 3.0L
--------	-------------	---------

INCLUYE JUNTA

**XR82523-FE**

BOMBA DE AGUA AUXILIAR





JAGUAR

S-TYPE	2000 - 2002	V8 4.0L
--------	-------------	---------

# BOMBAS DE AGUA



<b>04892713AB-EC</b>		<b>BOMBA DE AGUA</b>		
	<b>JEEP</b>	RENEGADE	2015	4 CIL. 1.4L

<b>4626054-LA / CARTER P-932</b>		<b>BOMBA DE AGUA</b>		
	<b>JEEP</b>	GRAND CHEROKEE	1995 - 1998	6 CIL. 4.0L
		WRANGLER	1995 - 1997	4 CIL. 2.5L
		WRANGLER	1997 - 1999	6 CIL. 4.0L
INCLUYE JUNTA				

<b>4792838AA-LA / CARTER P-9377</b>		<b>BOMBA DE AGUA</b>		
	<b>JEEP</b>	COMMANDER	2006 - 2008	V8 5.7L
		GRAND CHEROKEE	2005 - 2007	V8 5.7L
		GRAND CHEROKEE	2006 - 2010	V8 6.1L
INCLUYE O RING				

<b>5047138AB-LA / CARTER P-1982</b>		<b>BOMBA DE AGUA</b>		
	<b>JEEP</b>	COMPASS	2007 - 2014	4 CIL. 2.4L
		PATRIOT	2007 - 2014	4 CIL. 2.4L
INCLUYE JUNTA				



**5184498AD-LA / CARTER P-2408** BOMBA DE AGUA



**JEEP**

GRAND CHEROKEE	2011 - 2014	V6 3.6L
----------------	-------------	---------

INCLUYE JUNTA

**53020280-LA / CARTER P-951** BOMBA DE AGUA



**JEEP**

GRAND CHEROKEE	1993 - 1998	V8 5.2L
GRAND CHEROKEE	1998	V8 5.9L

INCLUYE JUNTA

**53021187AA-LA / CARTER P-927** BOMBA DE AGUA



**JEEP**

COMMANDER	2006 - 2010	V8 4.7L
GRAND CHEROKEE	2005 - 2010	V6 3.7L
GRAND CHEROKEE	2000 - 2010	V8 4.7L
LIBERTY	2002 - 2010	V6 3.7L

INCLUYE O RING

**6422002201-EC / CARTER P-2124** BOMBA DE AGUA



**JEEP**

GRAND CHEROKEE	2010	V6 3.0L
----------------	------	---------

INCLUYE JUNTA



**11511713266-EC** BOMBA DE AGUA



**LAND ROVER**

RANGE ROVER	2003 - 2005	V8 4.4L <small>WPR0021</small>
-------------	-------------	--------------------------------

**7T4Z8501B-LA / CARTER P-1983** BOMBA DE AGUA



**LINCOLN**

MKS	2009 - 2010	V6 3.7L
MKX	2007 - 2010	V6 3.5L
MKZ	2007 - 2012	V6 3.5L

INCLUYE O RINGS

**F65Z8501BA-LA / CARTER P-992** BOMBA DE AGUA



**LINCOLN**

BLACKWOOD	2003	V8 5.4L
-----------	------	---------

INCLUYE O RING

**1S7Z-8501AK-LA / CARTER P-2120** BOMBA DE AGUA



**MAZDA**

3	2006 - 2013	4 CIL. 2.0L
3	2006 - 2013	4 CIL. 2.3L
3	2010 - 2013	4 CIL. 2.5L
5	2006 - 2010	4 CIL. 2.3L
5	2012 - 2013	4 CIL. 2.5L
6	2006 - 2008	4 CIL. 2.3L
6	2009 - 2013	4 CIL. 2.5L
CX-7	2007 - 2012	4 CIL. 2.3L
CX-7	2010 - 2012	4 CIL. 2.5L



**7T4Z8501B-LA / CARTER P-1983**

**BOMBA DE AGUA**



**MAZDA**

6	2009 - 2012	V6 3.7L
CX-9	2008 - 2012	V6 3.7L

INCLUYE O RINGS

**1122001501-EC/ CARTER P-9243**

**BOMBA DE AGUA**

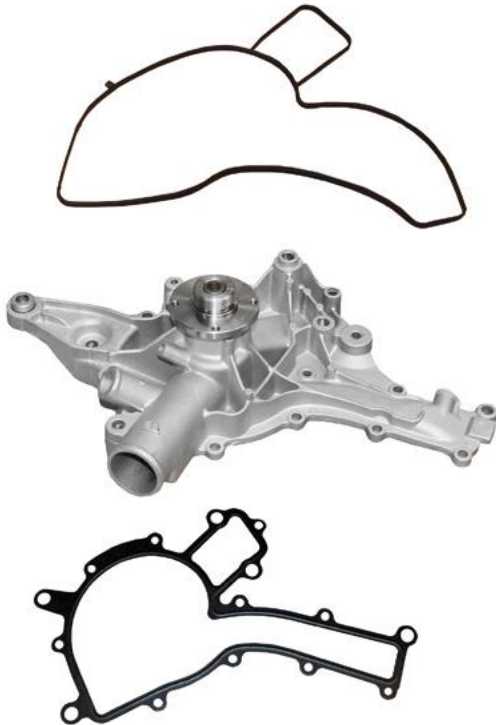

**MERCEDES BENZ**

C240	2001 - 2005	V6 2.6L
C280	1998	6 CIL. 2.8L
C280	1998 - 2000	V6 2.8L
C320	2001 - 2005	V6 3.2L
C43 AMG	1998 - 2000	V8 4.3L
CL500	2000 - 2006	V8 5.0L
CLK320	1998 - 2005	V6 3.2L
CLK430	1999 - 2003	V8 4.3L
CLK500	2003 - 2006	V8 5.0L
CLS500	2006	V8 5.0L
E320	1998 - 2005	V6 3.2L
E430	1998 - 2002	V8 4.3L
E500	2003 - 2006	V8 5.0L
E55 AMG	2002	V8 5.4L
E55 AMG	1999 - 2002	V8 5.5L
G500	2002 - 2008	V8 5.0L
G55 AMG	2003 - 2004	V8 5.5L
ML320	1998 - 2003	V6 3.2L
ML350	2003 - 2005	V6 3.7L
R500	2006 - 2007	V8 5.0L
S430	2000 - 2006	V8 4.3L
S500	2000 - 2006	V8 5.0L
SL500	1999 - 2006	V8 5.0L
SLK320	2001 - 2004	V6 3.2L

INCLUYE JUNTA

**18353564-FE**

**BOMBA DE AGUA AUXILIAR**



**MERCEDES BENZ**

C220	1994 - 1996	4 CIL. 2.2L
C230	1997 - 2000	4 CIL. 2.3L
C280	1994 - 1997	6 CIL. 2.8L
C280	1998 - 2000	V6 2.8L
CLK320	1998 - 2003	V6 3.2L
CLK430	1999 - 2003	V8 4.3L
E320	1998 - 2003	V6 3.2L
SL55 AMG	2003	V8 5.5L
SL500	2003	V8 5.0L



**18356064-FE** BOMBA DE AGUA AUXILIAR



MERCEDES BENZ

ML320	1998 - 2003	V6 3.2L
ML350	2003 - 2005	V6 3.7L
ML430	1999 - 2001	V8 4.3L
ML500	2002 - 2005	V8 5.0L
ML55 AMG	2000 - 2003	V8 5.5L
ML55 AMG	2002 - 2003	V8 5.4L

**2722000901-EC / CARTER P-2090** BOMBA DE AGUA



MERCEDES BENZ

C230	2006 - 2009	V6 2.5L
C250	2010 - 2012	V6 2.5L
C280	2006 - 2007	V6 3.0L
C300	2008 - 2012	V6 3.0L
C350	2006 - 2011	V6 3.5L
CLKJ350	2006 - 2009	V6 3.5L
E280	2007	V6 3.0L
E300	2008 - 2009	V6 3.0L
E350	2006 - 2011	V6 3.5L
GLK350	2010 - 2012	V6 3.5L
ML350	2006 - 2011	V6 3.5L
R350	2006 - 2011	V6 3.5L
SLK280	2006 - 2008	V6 3.0L
SLK350	2006 - 2011	V6 3.5L

INCLUYE O RING

**6422002201-EC / CARTER P-2124** BOMBA DE AGUA



MERCEDES BENZ

E320	2007 - 2009	V6 3.0L DIESEL
E350	2011 - 2013	V6 3.0L DIESEL
GL320	2007 - 2009	V6 3.0L DIESEL
GL350	2010 - 2016	V6 3.0L DIESEL
ML320	2007 - 2009	V6 3.0L DIESEL
ML350	2010 - 2015	V6 3.0L DIESEL
R320	2007 - 2009	V6 3.0L DIESEL
R350	2010 - 2013	V6 3.0L DIESEL
S350	2012 - 2013	V6 3.0L DIESEL
SPRINTER 2500	2010 - 2014	V6 3.0L DIESEL

INCLUYE JUNTA



**1S7Z-8501AK-LA / CARTER P-2120**

BOMBA DE AGUA



MERCURY

MARINER	2007	4 CIL. 2.3L
MILAN	2010	4 CIL. 2.5L

**2STZ8501BG-LA / CARTER P-9320**

BOMBA DE AGUA



MERCURY

MARINER	2005 - 2006	V6 3.0L
SABLE	2005	V6 3.0L

INCLUYE JUNTA

**F8RZ-8501EN-LA / CARTER P-994**

BOMBA DE AGUA



MERCURY

MYSTIQUE	1997 - 2000	4 CIL. 2.0L
----------	-------------	-------------

INCLUYE O RING

**11517513062-EC / CARTER P-9375**

BOMBA DE AGUA CON CUERPO TRASERO INTEGRADO



MINI

COOPER	2002 - 2008	4 CIL. 1.6L
--------	-------------	-------------

INCLUYE MANGUERA Y ABRAZADERAS



**11517520123-LA / CARTER P-9345** BOMBA DE AGUA



<b>MINI</b>	COOPER	2008 - 2011	4 CIL. 1.6L
	<small>CODIGO DE MOTOR N12816A</small>		

INCLUYE O RINGS

**1201H8-LA / CARTER P-2149** BOMBA DE AGUA



<b>MINI</b>	COOPER	2007 - 2014	4 CIL. 1.6L
	COOPER COUNTRYMAN	2011 - 2014	4 CIL. 1.6L
	COOPER PACEMAN	2013 - 2014	4 CIL. 1.6L

INCLUYE O RING

**4667660-LA / CARTER P-996** BOMBA DE AGUA



<b>MITSUBISHI</b>	ECLIPSE	1998 - 2000	4 CIL. 2.0L

INCLUYE O RING

**5047138AB-LA / CARTER P-1982** BOMBA DE AGUA



<b>MITSUBISHI</b>	LANCER	2008 - 2014	4 CIL. 2.0L
	LANCER	2009 - 2014	4 CIL. 2.4L
	OUTLANDER	2008 - 2014	4 CIL. 2.4L

INCLUYE JUNTA



**MD997244-LA / CARTER P-911** BOMBA DE AGUA



<b>NISSAN</b>	MIGHTY MAX PICKUP	1990 - 1994	V6 3.0L
	MONTERO	1989 - 1994	V6 3.0L

INCLUYE JUNTAS Y O RING

**2101000QAA-LA / CARTER P-1641** BOMBA DE AGUA

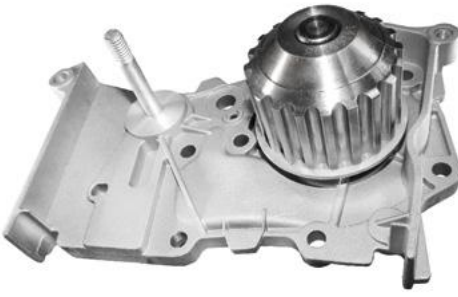

<b>NISSAN</b>	APRIO	2008 - 2011	4 CIL. 1.6L
	PLATINA	2002 - 2010	4 CIL. 1.6L

INCLUYE JUNTA

**2101001M25-LA / CARTER P-2195** BOMBA DE AGUA



<b>NISSAN</b>	TSURU	1984 - 1997	4 CIL. 1.6L 1,8 VÁLVULAS
---------------	-------	-------------	--------------------------

**210100W025-LA / CARTER P-9338** BOMBA DE AGUA



<b>NISSAN</b>	FRONTIER	1999 - 2004	V6 3.3L
	PATHFINDER	1996 - 2000	V6 3.3L
	XTERRA	2000 - 2004	V6 3.3L

INCLUYE JUNTA

# BOMBAS DE AGUA



**21010-13225-LA / CARTER P-2040-A** BOMBA DE AGUA

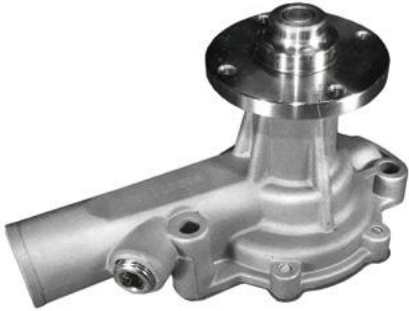

<b>NISSAN</b>	PICKUP	1976 - 1989	4 CIL. 1.6L
	PICKUP ESTAQUITAS	1982 - 1994	4 CIL. 1.8L

INCLUYE JUNTA

**2101016E02-LA / CARTER P-2258** BOMBA DE AGUA



<b>NISSAN</b>	MAXIMA	1991 - 1994	V6 3.0L
	QUEST	1997 - 2000	V6 3.0L

INCLUYE JUNTA

**210101E400-LA / CARTER P-2453** BOMBA DE AGUA



<b>NISSAN</b>	ALTIMA	1995 - 2001	4 CIL. 2.4L
---------------	--------	-------------	-------------

INCLUYE JUNTA

**210107Y025-LA / CARTER P-9276** BOMBA DE AGUA



<b>NISSAN</b>	350Z	2003 - 2009	V6 3.5L
	350ZX	2003 - 2004	V6 3.5L
	370Z	2008 - 2011	V6 3.7L
	ALTIMA	2002 - 2005	V6 3.5L
	FRONTIER	2005 - 2007	V6 4.0L
	MAXIMA	2002 - 2008	V6 3.5L
	MURANO	2003 - 2005	V6 3.5L
	NV 2500	2012 - 2014	V6 4.0L
	PATHFINDER	2005 - 2010	V6 4.0L
	QUEST	2004 - 2011	V6 3.5L
XTERRA	2005 - 2008	V6 4.0L	

INCLUYE O RING



**2101086G00-LA / CARTER P-2347** BOMBA DE AGUA



NISSAN	240SX	1991 - 1998	4 CIL. 2.4L
	ESTAQUITAS	1995 - 2001	4 CIL. 2.4L
	FRONTIER	2001 - 2007	4 CIL. 2.4L
	ICHI VAN	1991 - 1994	4 CIL. 2.4L
	KING CAB	1997 - 2002	4 CIL. 2.4L
	PICKUP NP300	2008 - 2011	4 CIL. 2.4L
	PICKUP	1995 - 2005	4 CIL. 2.4L
	URVAN	2001 - 2010	4 CIL. 2.4L
XTERRA	2000 - 2005	4 CIL. 2.4L	

INCLUYE JUNTA

**210108J000-LA / CARTER P-9427** BOMBA DE AGUA



NISSAN	ALTIMA	2002 - 2013	4 CIL. 2.5L
	ROGUE	2008 - 2013	4 CIL. 2.5L
	SENTRA	2002 - 2010	4 CIL. 2.5L
	URVAN	2009 - 2013	4 CIL. 2.5L
	X-TRAIL	2002 - 2009	4 CIL. 2.5L

INCLUYE JUNTA

**21010F4300-LA / CARTER P-2198** BOMBA DE AGUA



NISSAN	LUCINO	1996 - 2000	4 CIL. 1.6L
	SENTRA	1995 - 2000	4 CIL. 1.6L
	TSUBAME	1992 - 2004	4 CIL. 1.6L
	TSURU	1988 - 2010	4 CIL. 1.6L <sup>16 VÁLVULAS</sup>

INCLUYE JUNTAS

**21010-F4600-LA / CARTER P-9416** BOMBA DE AGUA



NISSAN	ALMERA	2001 - 2005	4 CIL. 1.8L
	SENTRA	2001 - 2006	4 CIL. 1.8L



**B1010-ED00A-LA / CARTER P-2373** BOMBA DE AGUA



<b>NISSAN</b>	MARCH	2011 - 2012	4 CIL. 1.6L
	VERSA	2011 - 2012	4 CIL. 1.6L

**B1010ET00A-LA / CARTER P-2118** BOMBA DE AGUA



<b>NISSAN</b>	SENTRA	2007 - 2012	4 CIL. 2.0L
	TIIDA	2007 - 2012	4 CIL. 1.8L
	VERSA	2010 - 2011	4 CIL. 1.8L

INCLUYE JUNTA

**1201E5-LA / CARTER P-2482** BOMBA DE AGUA



<b>PEUGEOT</b>	206	2000 - 2008	4 CIL. 1.6L POLEA DE 20 DIENTES
	207	2008	4 CIL. 1.6L POLEA DE 20 DIENTES
	308	2008	4 CIL. 1.6L POLEA DE 20 DIENTES
	GRAND RAID	2007 - 2009	4 CIL. 1.6L POLEA DE 20 DIENTES
	PARTNER	2003 - 2009	4 CIL. 1.6L POLEA DE 20 DIENTES

INCLUYE O RING

**1201G0-LA / CARTER P-1887** BOMBA DE AGUA



<b>PEUGEOT</b>	206	2000 - 2008	4 CIL. 1.4L POLEA DE 18 DIENTES
----------------	-----	-------------	---------------------------------

INCLUYE O RING



**1201H8-LA / CARTER P-2149**

**BOMBA DE AGUA**



**PEUGEOT**

207	2008 - 2012	4 CIL. 1.6L
208	2011 - 2012	4 CIL. 1.6L
RCZ	2011 - 2012	4 CIL. 1.6L

INCLUYE O RING

**10048949-LA / CARTER P-864**

**BOMBA DE AGUA**



**PONTIAC**

AZTEK	2001 - 2005	V6 3.4L
G6	2005 - 2006	V6 3.5L
GRAND AM	1998	V6 3.1L
GRAND AM	1999 - 2005	V6 3.4L
GRAND PRIX	1997 - 2002	V6 3.1L
MONTANA	2005 - 2006	V6 3.5L

INCLUYE JUNTA

**12518443-LA / CARTER P-860**

**BOMBA DE AGUA**



**PONTIAC**

SUNFIRE	1997 - 2002	4 CIL. 2.2L
---------	-------------	-------------

INCLUYE JUNTA

**12618472-LA / CARTER P-9361**

**BOMBA DE AGUA**



**PONTIAC**

G6	2007 - 2009	V6 3.6L
----	-------------	---------

INCLUYE JUNTA

# BOMBAS DE AGUA



**19179031-LA / CARTER P-2093** BOMBA DE AGUA



<b>PONTIAC</b>	TORRENT	2006 - 2008	V6 3.4L
----------------	---------	-------------	---------

INCLUYE JUNTA

**89017757-LA / CARTER P-2061** BOMBA DE AGUA



<b>PONTIAC</b>	G4	2006	4 CIL. 2.4L
	G6	2007 - 2010	V6 3.5L
	MONTANA	2006 - 2009	V6 3.9L

INCLUYE JUNTA

**93181118-LA / CARTER P-5092** BOMBA DE AGUA



<b>PONTIAC</b>	G4	2005 - 2006	4 CIL. 2.2L
	G5	2007 - 2009	4 CIL. 2.4L
	GRAND AM	2002 - 2005	4 CIL. 2.2L
	SOLSTICE	2006 - 2008	4 CIL. 2.4L
	SOLSTICE	2007 - 2009	4 CIL. 2.0L
	SUNFIRE	2003 - 2005	4 CIL. 2.2L

INCLUYE O RINGS

**9666219-LA / CARTER P-1646** BOMBA DE AGUA



<b>PONTIAC</b>	MATIZ G2	2003 - 2009	4 CIL. 1.0L
----------------	----------	-------------	-------------

INCLUYE JUNTA



**96872702-LA / CARTER P-1633** BOMBA DE AGUA



<b>PONTIAC</b>	G3	2006 - 2009	4 CIL. 1.6L
----------------	----	-------------	-------------

INCLUYE O RING

**06E121005F-LA / CARTER P-2094** BOMBA DE AGUA



<b>PORSCHE</b>	CAYENNE	2011 - 2015	V6 3.0L
	PANAMERA	2012 - 2014	V6 3.0L

INCLUYE JUNTA

**94810601104-EC** BOMBA DE AGUA



<b>PORSCHE</b>	CAYENNE	2003 - 2006	V8 4.5L
----------------	---------	-------------	---------

INCLUYE JUNTA

**95557215002-FE** BOMBA DE AGUA AUXILIAR



<b>PORSCHE</b>	CAYENNE	2003 - 2006	V8 4.5L
	CAYENNE	2004 - 2006	V6 3.2L

# BOMBAS DE AGUA



**2101000QAA-LA / CARTER P-1641** BOMBA DE AGUA



<b>RENAULT</b>	CLIO	2003 - 2009	4 CIL. 1.6L
	EURO CLIO	2007 - 2009	4 CIL. 1.6L
	KANGOO	2005 - 2012	4 CIL. 1.6L
	KANGOO E.	2004 - 2009	4 CIL. 1.6L
	MEGANE	2008 - 2009	4 CIL. 1.6L
	SANDERO	2010 - 2011	4 CIL. 1.6L
	STEPWAY	2010 - 2011	4 CIL. 1.6L

INCLUYE JUNTA

**210108J000-LA / CARTER P-9427** BOMBA DE AGUA



<b>RENAULT</b>	KOLEOS	2009 - 2013	4 CIL. 2.5L
----------------	--------	-------------	-------------

INCLUYE JUNTA

**7701479043-LA / CARTER P-255** BOMBA DE AGUA



<b>RENAULT</b>	DUSTER	2012 - 2013	4 CIL. 1.6L
	MEGANE	2004 - 2009	4 CIL. 2.0L
	SCENIC	2005 - 2008	4 CIL. 2.0L
	TRAFIC	2008 - 2009	4 CIL. 1.9L DIESEL

INCLUYE JUNTA

**12618472-LA / CARTER P-9361** BOMBA DE AGUA



<b>SAAB</b>	9-3	2007 - 2009	V6 2.8L
-------------	-----	-------------	---------

INCLUYE JUNTA



**90543277-LA / CARTER P-9107** BOMBA DE AGUA



9-5	2002	V6 3.0L
-----	------	---------

**SAAB**

INCLUYE O RING

**93181118-LA / CARTER P-5092** BOMBA DE AGUA



9-3	2006 - 2009	4 CIL. 2.0L
-----	-------------	-------------

**SAAB**

INCLUYE O RINGS

**030121008L-LA / CARTER P-2259** BOMBA DE AGUA



CORDOBA	2003 - 2009	4 CIL. 1.6L
IBIZA	2003 - 2009	4 CIL. 1.6L

**SEAT**

INCLUYE O RING

**03C121005N-LA / CARTER P-2154** BOMBA DE AGUA



ALTEA	2010 - 2012	4 CIL. 1.4L <sup>TURBO</sup>
-------	-------------	------------------------------

**SEAT**

INCLUYE O RING



**03C121008J-LA / CARTER P-2155** BOMBA DE AGUA



SEAT	IBIZA	2011 - 2015	4 CIL. 1.6L
	TOLEDO	2013 - 2017	4 CIL. 1.6L

INCLUYE O RING

**06A121012E-LA / CARTER P-2030** BOMBA DE AGUA



SEAT	ALHAMBRA	2001 - 2007	4 CIL. 1.8L <small>20 VÁLVULAS</small>
	CORDOBA	2000 - 2003	4 CIL. 1.8L <small>20 VÁLVULAS</small>
	CORDOBA	2003 - 2009	4 CIL. 2.0L
	IBIZA	2003 - 2008	4 CIL. 1.8L <small>20 VÁLVULAS</small>
	IBIZA	2003 - 2009	4 CIL. 2.0L
	LEON	2000 - 2006	4 CIL. 1.8L <small>20 VÁLVULAS</small>
	TOLEDO	2000 - 2004	4 CIL. 1.8L <small>20 VÁLVULAS</small>

INCLUYE O RING

**06B121011M-LA / CARTER P-1903** BOMBA DE AGUA



SEAT	LEON	2007 - 2009	4 CIL. 2.0L <small>FSI (BLR, BLY)</small>
------	------	-------------	---

INCLUYE O RING

**06F121011-LA / CARTER P-1103** BOMBA DE AGUA



SEAT	ALTEA	2010	4 CIL. 2.0L <small>SPORT, TURBO</small>
	EXEO	2011 - 2012	4 CIL. 2.0L <small>TURBO</small>
	LEON	2007 - 2009	4 CIL. 2.0L <small>TURBO, TFSI (MOTOR BWA)</small>

INCLUYE O RING



**12618472-LA / CARTER P-9361** BOMBA DE AGUA



<b>SUZUKI</b>	GRAND VITARA	2009 - 2010	V6 3.2L
	XL-7	2007 - 2009	V6 3.6L

INCLUYE JUNTA

**1740069G04-LA / CARTER P-194** BOMBA DE AGUA



<b>SUZUKI</b>	SWIFT	2007 - 2011	4 CIL. 1.5L
---------------	-------	-------------	-------------

INCLUYE JUNTA

**16100-09140-LA / CARTER P-1892** BOMBA DE AGUA



<b>TOYOTA</b>	YARIS	2003 - 2006	4 CIL. 1.3L
---------------	-------	-------------	-------------

INCLUYE JUNTA

**161000H010-LA / CARTER P-9414** BOMBA DE AGUA



<b>TOYOTA</b>	CAMRY	2002 - 2011	4 CIL. 2.4L
	COROLLA	2009 - 2010	4 CIL. 2.4L
	MATRIX	2009 - 2011	4 CIL. 2.4L
	RAV4	2001 - 2003	4 CIL. 2.0L
	RAV4	2004 - 2008	4 CIL. 2.4L
	SOLARA	2002 - 2007	4 CIL. 2.4L

INCLUYE JUNTA

# BOMBAS DE AGUA



**16100-29155-LA / CARTER P-9187** BOMBA DE AGUA



<b>TOYOTA</b>	YARIS	2006 - 2013	4 CIL. 1.5L
---------------	-------	-------------	-------------

INCLUYE JUNTA

**16100-29415-LA / CARTER P-9173** BOMBA DE AGUA



<b>TOYOTA</b>	COROLLA	1998 - 2008	4 CIL. 1.8L
	MATRIX	2007 - 2008	4 CIL. 1.8L

INCLUYE O RING

**1610039515-LA / CARTER P-225** BOMBA DE AGUA



<b>TOYOTA</b>	CAMRY	2010 - 2013	4 CIL. 2.5L
	RAV4	2009 - 2012	4 CIL. 2.5L

INCLUYE JUNTA

**021121004A-LA / CARTER P-2397** BOMBA DE AGUA



<b>VOLKSWAGEN</b>	EUROVAN	1996 - 2004	V6 2.8L
	GOLF	1993 - 1996	V6 2.8L <sup>VR6</sup>
	GOLF	1999 - 2001	V6 2.8L <sup>VR6</sup>
	JETTA	1993 - 1996	V6 2.8L <sup>VR6</sup>



**022121011A-LA / CARTER P-2142** BOMBA DE AGUA



<b>VOLKSWAGEN</b>	PASSAT	2006 - 2010	V6 3.6L
	PASSAT	2012 - 2014	V6 3.6L
	PASSAT CC	2009 - 2012	V6 3.6L
	TOUAREG	2007 - 2013	V6 3.6L

INCLUYE O RING

**022121011V-LA / CARTER P-9366** BOMBA DE AGUA



<b>VOLKSWAGEN</b>	GOLF	2004	V6 3.2L <small>IMPULSOR DE 7 ASPAS</small>
	JETTA	2002 - 2003	V6 2.8L <small>IMPULSOR DE 7 ASPAS</small>
	TOUAREG	2004 - 2007	V6 3.2L <small>IMPULSOR DE 7 ASPAS</small>

INCLUYE O RING

**026121005H-LA / CARTER P-1892** BOMBA DE AGUA



<b>VOLKSWAGEN</b>	ATLANTIC	1978 - 1982	4 CIL. 1.6L <small>MAZA DE 30 MM</small>
	ATLANTIC	1982 - 1986	4 CIL. 1.7L <small>MAZA DE 30 MM</small>
	ATLANTIC	1984 - 1987	4 CIL. 1.8L <small>MAZA DE 30 MM</small>
	CABRIO	1999 - 2004	4 CIL. 2.0L <small>MAZA DE 30 MM</small>
	CARAVELLE	1989 - 1996	4 CIL. 1.8L <small>MAZA DE 30 MM</small>
	CARIBE	1978 - 1984	4 CIL. 1.6L <small>MAZA DE 30 MM</small>
	CARIBE	1982 - 1986	4 CIL. 1.7L <small>MAZA DE 30 MM</small>
	CARIBE	1984 - 1987	4 CIL. 1.8L <small>MAZA DE 30 MM</small>
	COMBI	1988 - 2002	4 CIL. 1.8L <small>MAZA DE 30 MM</small>
	CORSAR	1983 - 1988	4 CIL. 1.8L <small>MAZA DE 30 MM</small>
	DERBY	1995 - 2005	4 CIL. 1.8L <small>MAZA DE 30 MM</small>
	GOLF	1987 - 1999	4 CIL. 1.8L <small>MAZA DE 30 MM</small>
	GOLF	1993 - 1998	4 CIL. 2.0L <small>MAZA DE 30 MM</small>
	JETTA	1987 - 1999	4 CIL. 1.8L <small>MAZA DE 30 MM</small>
	JETTA	1993 - 1999	4 CIL. 2.0L <small>MAZA DE 30 MM</small>
	PANEL	1988 - 2002	4 CIL. 1.8L <small>MAZA DE 30 MM</small>
	PASSAT	1994 - 1997	4 CIL. 2.0L <small>MAZA DE 30 MM</small>
	POINTER	1998 - 2009	4 CIL. 1.8L <small>MAZA DE 30 MM</small>
POINTER	2002 - 2005	4 CIL. 2.0L <small>MAZA DE 30 MM</small>	
POINTER PICKUP	2003 - 2009	4 CIL. 1.8L <small>MAZA DE 30 MM</small>	
VAN	2003 - 2009	4 CIL. 1.8L <small>MAZA DE 30 MM</small>	

INCLUYE JUNTA



**030121008L-LA / CARTER P-2259** BOMBA DE AGUA



VOLKSWAGEN

CROSSFOX	2007 - 2012	4 CIL. 1.6L
GOL	2009 - 2013	4 CIL. 1.6L
LUPO	2005 - 2011	4 CIL. 1.6L
POLO	2003 - 2007	4 CIL. 1.6L
SAVEIRO	2010 - 2013	4 CIL. 1.6L
SPORTVAN	2007 - 2011	4 CIL. 1.6L

INCLUYE O RING

**037121010C-LA / CARTER P-2548** BOMBA DE AGUA

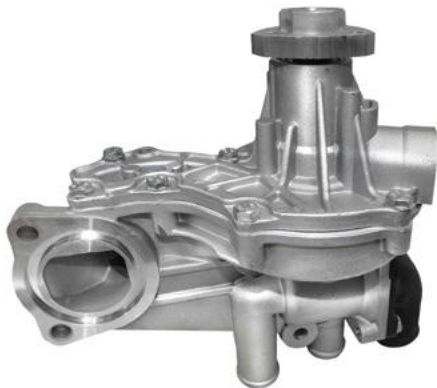

VOLKSWAGEN

ATLANTIC	1978 - 1982	4 CIL. 1.6L	CUERPO INFERIOR INTEGRADO
ATLANTIC	1982 - 1986	4 CIL. 1.7L	CUERPO INFERIOR INTEGRADO
ATLANTIC	1984 - 1987	4 CIL. 1.8L	CUERPO INFERIOR INTEGRADO
CABRIO	1999 - 2004	4 CIL. 2.0L	CUERPO INFERIOR INTEGRADO
CARAVELLE	1989 - 1996	4 CIL. 1.8L	CUERPO INFERIOR INTEGRADO
CARIBE	1978 - 1984	4 CIL. 1.6L	CUERPO INFERIOR INTEGRADO
CARIBE	1982 - 1986	4 CIL. 1.7L	CUERPO INFERIOR INTEGRADO
CARIBE	1984 - 1987	4 CIL. 1.8L	CUERPO INFERIOR INTEGRADO
COMBI	1988 - 2002	4 CIL. 1.8L	CUERPO INFERIOR INTEGRADO
CORSAR	1983 - 1988	4 CIL. 1.8L	CUERPO INFERIOR INTEGRADO
DERBY	1995 - 2005	4 CIL. 1.8L	CUERPO INFERIOR INTEGRADO
GOLF	1987 - 1999	4 CIL. 1.8L	CUERPO INFERIOR INTEGRADO
GOLF	1993 - 1998	4 CIL. 2.0L	CUERPO INFERIOR INTEGRADO
JETTA	1987 - 1999	4 CIL. 1.8L	CUERPO INFERIOR INTEGRADO
JETTA	1993 - 1999	4 CIL. 2.0L	CUERPO INFERIOR INTEGRADO
PANEL	1988 - 2002	4 CIL. 1.8L	CUERPO INFERIOR INTEGRADO
PASSAT	1994 - 1997	4 CIL. 2.0L	CUERPO INFERIOR INTEGRADO
POINTER	1998 - 2009	4 CIL. 1.8L	CUERPO INFERIOR INTEGRADO
POINTER	2002 - 2005	4 CIL. 2.0L	CUERPO INFERIOR INTEGRADO
POINTER PICKUP	2003 - 2009	4 CIL. 1.8L	CUERPO INFERIOR INTEGRADO
VAN	2003 - 2009	4 CIL. 1.8L	CUERPO INFERIOR INTEGRADO

INCLUYE JUNTA

**038121011A-LA / CARTER P-9378** BOMBA DE AGUA



VOLKSWAGEN

BEETLE	1999 - 2003	4 CIL. 1.9L DIESEL	MOTOR ALH
GOLF	1999 - 2004	4 CIL. 1.9L DIESEL	MOTOR ALH
JETTA	1999 - 2004	4 CIL. 1.9L DIESEL	MOTOR ALH

INCLUYE O RING



**038121011K-LA / CARTER P-1978** BOMBA DE AGUA



<b>VOLKSWAGEN</b>	BEETLE	2004 - 2006	4 CIL. 1.9L DIESEL <small>MOTOR BEW</small>
	GOLF	2004 - 2006	4 CIL. 1.9L DIESEL <small>MOTOR BEW</small>
	JETTA	2004 - 2008	4 CIL. 1.9L DIESEL <small>MOTOR BEW</small>

INCLUYE O RING

**03C121008J-LA / CARTER P-2155** BOMBA DE AGUA



<b>VOLKSWAGEN</b>	POLO	2016 - 2017	4 CIL. 1.6L
	VENTO	2015 - 2017	4 CIL. 1.6L

INCLUYE O RING

**03L121011C-LA / CARTER P-226** BOMBA DE AGUA



<b>VOLKSWAGEN</b>	AMAROK	2010 - 2011	4 CIL. 2.0L DIESEL TDI
	TRANSPORTER	2010 - 2011	4 CIL. 2.0L DIESEL TDI

**045121011HX-LA / CARTER P-1878** BOMBA DE AGUA



<b>VOLKSWAGEN</b>	BORA	2008 - 2010	4 CIL. 1.9L DIESEL
	EUROVAN	2006 - 2009	4 CIL. 1.9L DIESEL

INCLUYE O RING



**068121005B-LA / CARTER P-2025** BOMBA DE AGUA



VOLKSWAGEN	ATLANTIC	1978 - 1982	4 CIL. 1.6L MAZA DE 40 MM.
	ATLANTIC	1982 - 1986	4 CIL. 1.7L MAZA DE 40 MM.
	ATLANTIC	1984 - 1987	4 CIL. 1.8L MAZA DE 40 MM.
	CARIBE	1978 - 1984	4 CIL. 1.6L MAZA DE 40 MM.
	CARIBE	1982 - 1986	4 CIL. 1.7L MAZA DE 40 MM.
	CARIBE	1984 - 1987	4 CIL. 1.8L MAZA DE 40 MM.
	COMBI	1988 - 1993	4 CIL. 1.8L MAZA DE 40 MM.
	PANEL	1988 - 1993	4 CIL. 1.8L MAZA DE 40 MM.

INCLUYE JUNTA

**06A121012E-LA / CARTER P-2030** BOMBA DE AGUA



VOLKSWAGEN	BEETLE	2000 - 2005	4 CIL. 1.8L TURBO
	BEETLE	1999 - 2010	4 CIL. 2.0L
	GOLF	1999 - 2007	4 CIL. 2.0L
	JETTA	2000 - 2005	4 CIL. 1.8L TURBO
	JETTA	1999 - 2010	4 CIL. 2.0L
	PASSAT	1999 - 2005	4 CIL. 1.8L TURBO
	POINTER	2000 - 2003	4 CIL. 2.0L
	SHARAN	2003 - 2008	4 CIL. 1.8L TURBO

INCLUYE O RING

**06E121005F-LA / CARTER P-2094** BOMBA DE AGUA



VOLKSWAGEN	TOUAREG	2009 - 2013	V6 3.0L
------------	---------	-------------	---------

INCLUYE O RING

**06F121011-LA / CARTER P-1103** BOMBA DE AGUA



VOLKSWAGEN	BORA	2006	4 CIL. 2.0L TURBO
	PASSAT	2006 - 2010	4 CIL. 2.0L TURBO

INCLUYE O RING



**06H121026AB-KT1** KIT BOMBA DE AGUA



**VOLKSWAGEN**

EOS	2009 - 2011	4 CIL. 2.0L
GTI	2008 - 2011	4 CIL. 2.0L
PASSAT CC	2009 - 2011	4 CIL. 2.0L
TIGUAN	2009 - 2011	4 CIL. 2.0L

**06H121026AB-KT2** KIT BOMBA DE AGUA



**VOLKSWAGEN**

EOS	2009 - 2011	4 CIL. 2.0L
GTI	2008 - 2011	4 CIL. 2.0L
PASSAT CC	2009 - 2011	4 CIL. 2.0L
TIGUAN	2009 - 2011	4 CIL. 2.0L

INCLUYE O RING, BANDA Y TORNILLOS

**06H121026AF-LA / CARTER P-237** BOMBA DE AGUA



**VOLKSWAGEN**

EOS	2009 - 2011	4 CIL. 2.0L
GTI	2008 - 2011	4 CIL. 2.0L
PASSAT CC	2009 - 2011	4 CIL. 2.0L
TIGUAN	2009 - 2011	4 CIL. 2.0L

INCLUYE O RING

**070121011D-LA / CARTER P-2056** BOMBA DE AGUA



**VOLKSWAGEN**

BORA	2007 - 2010	5 CIL. 2.5L DIESEL
EUROVAN	2003 - 2005	5 CIL. 2.5L DIESEL
TOUAREG	2007 - 2009	5 CIL. 2.5L DIESEL
TRANSPORTER	2008 - 2011	5 CIL. 2.5L DIESEL

# BOMBAS DE AGUA



**074121005N-LA / CARTER P-2492** BOMBA DE AGUA

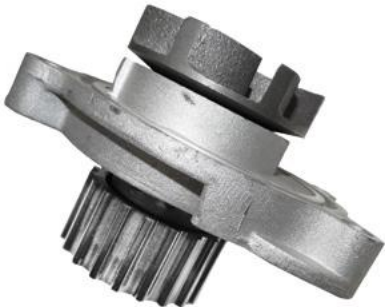

**VOLKSWAGEN**

EUROVAN	2001 - 2005	5 CIL. 2.5L
---------	-------------	-------------

INCLUYE O RING

**077121004M-LA / CARTER P-9340** BOMBA DE AGUA



**VOLKSWAGEN**

TOUAREG	2004 - 2007	V8 4.2L
---------	-------------	---------

INCLUYE JUNTA

**078121006-LA / CARTER P-2466** BOMBA DE AGUA



**VOLKSWAGEN**

PASSAT	1998 - 2005	V6 2.8L
--------	-------------	---------

INCLUYE JUNTA

**07K121011B-LA / CARTER P-2067** BOMBA DE AGUA



**VOLKSWAGEN**

BEETLE	2006 - 2013	5 CIL. 2.5L
BORA	2005 - 2010	5 CIL. 2.5L
JETTA	2011 - 2014	5 CIL. 2.5L

INCLUYE O RING



**1K0965561G-FE** BOMBA DE AGUA AUXILIAR



**VOLKSWAGEN**

GTI	2006 - 2008	4 CIL. 2.0L
JETTA	2006 - 2008	4 CIL. 2.0L
PASSAT	2006 - 2008	4 CIL. 2.0L

**1K0965561J-FE** BOMBA DE AGUA AUXILIAR



**VOLKSWAGEN**

BEETLE	2012 - 2013	4 CIL. 2.0
EOS	2009 - 2011	4 CIL. 2.0
GOLF	2013	4 CIL. 2.0
GTI	2009 - 2014	4 CIL. 2.0
JETTA	2009 - 2010	4 CIL. 2.0
JETTA	2012 - 2013	4 CIL. 2.0
PASSAT	2009 - 2010	4 CIL. 2.0
PASSAT CC	2009 - 2010	4 CIL. 2.0
TIGUAN	2009 - 2015	4 CIL. 2.0

**4648952AE-LA / CARTER P-2156** BOMBA DE AGUA



**VOLKSWAGEN**

ROUTAN	2009 - 2010	V6 3.8L
--------	-------------	---------

INCLUYE JUNTA

**4792968AD-LA / CARTER P-1107** BOMBA DE AGUA



**VOLKSWAGEN**

ROUTAN	2010	V6 4.0L
--------	------	---------

INCLUYE O RING

# BOMBAS DE AGUA



**5184498AD-LA / CARTER P-2408** BOMBA DE AGUA



VOLKSWAGEN	ROUTAN	2011 - 2012	V6 3.6L
------------	--------	-------------	---------

INCLUYE JUNTA

**95557215002-FE** BOMBA DE AGUA AUXILIAR



VOLKSWAGEN	TOUAREG	2005 - 2006	V8 4.2L
------------	---------	-------------	---------

INCLUYE JUNTA

**272474-EC / CARTER P-2483** BOMBA DE AGUA

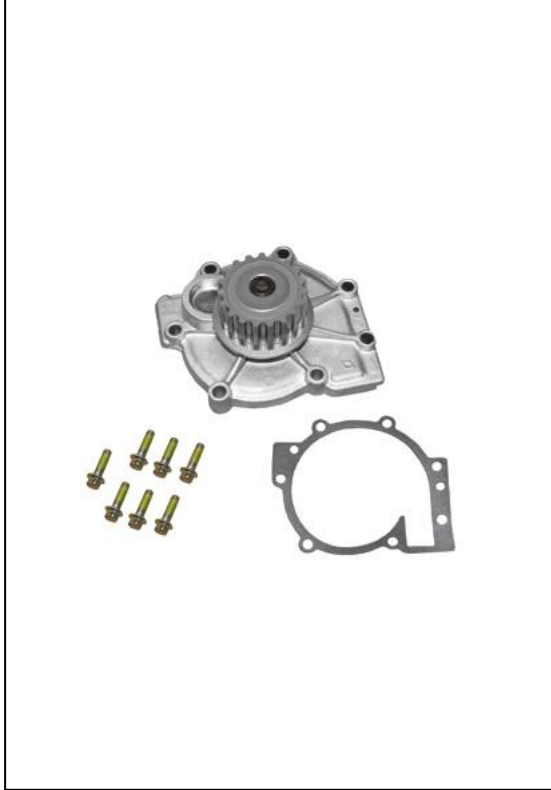

VOLVO	C30	2007 - 2010	5 CIL. 2.4L
	C30	2007 - 2013	5 CIL. 2.5L
	C70	1998 - 2004	5 CIL. 2.3L
	C70	1998 - 2004	5 CIL. 2.4L
	C70	2006 - 2013	5 CIL. 2.5L
	S40	2000 - 2004	4 CIL. 1.9L
	S40	2004 - 2010	5 CIL. 2.4L
	S40	2004 - 2011	5 CIL. 2.5L
	S60	2001 - 2004	5 CIL. 2.3L
	S60	2001 - 2009	5 CIL. 2.4L
	S60	2003 - 2009	5 CIL. 2.5L
	S60	2012 - 2016	5 CIL. 2.5L
	S70	1998 - 2000	5 CIL. 2.3L
	S70	1998 - 2000	5 CIL. 2.4L
S80	2004 - 2006	5 CIL. 2.5L	
V40	2000 - 2004	4 CIL. 1.9L	
V50	2005 - 2010	5 CIL. 2.4L	
V50	2005 - 2011	5 CIL. 2.5L	

INCLUYE JUNTA



**272474-EC / CARTER P-2483**

**BOMBA DE AGUA**



**VOLVO**

V60	2015	5 CIL. 2.5L
V70	1998 - 2004	5 CIL. 2.3L
V70	1998 - 2007	5 CIL. 2.4L
V70	2003 - 2007	5 CIL. 2.5L
XC60	2015 - 2016	5 CIL. 2.5L
XC70	2016	5 CIL. 2.5L
XC70	2003 - 2007	5 CIL. 2.5L
XC90	2003 - 2006	5 CIL. 2.5L

INCLUYE O RING

**8694627-EC / CARTER P-9336**

**BOMBA DE AGUA**



**VOLVO**

S80	1999 - 2001	6 CIL. 2.8L
S80	1999 - 2002	6 CIL. 2.9L

INCLUYE JUNTA

**8694630-EC**

**BOMBA DE AGUA**



**VOLVO**

S80	2003 - 2005	6 CIL. 2.9L
XC90	2003 - 2005	6 CIL. 2.9L

MEISTERSATZ	CARTER	MEISTERSATZ	CARTER
021121004A-LA	P-2397	210100W025-LA	P-9338
022121011A-LA	P-2142	21010-13225-LA	P-2040-A
022121011V-LA	P-9366	2101016E02-LA	P-2258
026121005H-LA	P-2190	210101E400-LA	P-2453
030121008L-LA	P-2259	210107Y025-LA	P-9276
037121010C-LA	P-2548	2101086G00-LA	P-2347
038121011A-LA	P-9378	210108J000-LA	P-9427
038121011K-LA	P-1978	21010F4300-LA	P-2198
03C121005N-LA	P-2154	21010-F4600-LA	P-9416
03C121008J-LA	P-2155	24405895-LA	P-1700
03L121011C-LA	P-226	2510002577-LA	P-1101
045121011HX-LA	P-1878	2510012501-LA	P-972
04892713AB-EC		2510026902-LA	P-9139
068121005B-LA	P-2025	2510042541-LA	P-2171
06A121012E-LA	P-2030	2722000901-EC	P-2090
06B121011M-LA	P-1903	272474-EC	P-2483
06C121004H-LA	P-9356	2STZ8501BG-LA	P-9320
06E121005F-LA	P-2094	4483453-LA	P-898
06E121005G-LA	P-2224	4626054-LA	P-932
06F121011-LA	P-1103	4648952AE-LA	P-2156
06H121026AB-KT1		4667660-LA	P-996
06H121026AB-KT2		4694307AC-LA	P-2422
06H121026AF-LA	P-237	4781157AA-LA	P-7165
070121011D-LA	P-2056	4792838AA-LA	P-9377
074121005N-LA	P-2492	4792968AD-LA	P-1107
076121005A-LA	P-2492	5010898AA-LA	P-897
077121004M-LA	P-9340	5047138AB-LA	P-1982
078121006-LA	P-2466	5184498AD-LA	P-2408
079121014D-LA	P-9324	53011380AG-LA	P-9303
07K121011B-LA	P-2067	53020280-LA	P-951
10048917-LA	P-665	53021187AA-LA	P-927
10048949-LA	P-864	64116988960-FE	
1020538-LA	P-547	6422002201-EC	P-2124
1020567-LA	P-545	7701479043-LA	P-255
1122001501-EC	P-9243	7S7G8505A2A-LA	P-157
11511713266-EC		7T4Z8501B-LA	P-1983
11517503884-LA	P-2370	8694627-EC	P-9336
11517513062-EC	P-9375	8694630-EC	
11517520123-LA	P-9345	89017757-LA	P-2061
11517524551-EC		90392901-LA	P-2364
11517586925-EC		90543277-LA	P-9107
11517838118-EC		90543935-LA	P-1642
1201E5-LA	P-2482	93181118-LA	P-5092
1201G0-LA	P-1887	93284724-LA	P-1447
1201H8-LA	P-2149	93284725-LA	P-1448
12518443-LA	P-860	93385844-LA	P-1619
12522031-LA	P-910	94810601104-EC	
12532528-LA	P-968	96416294-LA	P-451
12618472-LA	P-9361	96666219-LA	P-1646
16100-09140-LA	P-1892	96872702-LA	P-1633
161000H010-LA	P-9414	B1010-ED00A-LA	P-2373
16100-29155-LA	P-9187	B1010ET00A-LA	P-2118
16100-29415-LA	P-9173	BR3Z8501H-LA	P-2415
1610039515-LA	P-225	C2C6517-FE	
1740069G04-LA	P-194	D0AZ8501F-LA	P-548
18353564-FE		F4DZ8501A-LA	P-960
18356064-FE		F5TZ8501C-LA	P-909
19179031-LA	P-2093	F63Z8501AA-LA	P-959
19200P2AA01-LA	P-2459	F65Z8501AC-LA	P-979
19200P8AA02-LA	P-2455	F65Z8501BA-LA	P-992
19200-RB0-003-LA	P-2280	F68Z8501A-LA	P-982
19200RFE003-LA	P-9314	F77Z8501AD-LA	P-965
19200-RNAA02-LA	P-2058	F8RZ-8501EN-LA	P-994
1K0965561G-FE		M2S6G8591AA-LA	P-546
1K0965561J-FE		MD997244-LA	P-911
1S7Z-8501AK-LA	P-2120	XR82523-FE	
2101000QAA-LA	P-1641	YS4Z-8501AA-LA	P-4123
2101001M25-LA	P-2195		

**Continental** 

**ContiTech**



THE FLUID LABS  
SINCE 1927

**MEISTERSATZ**<sup>®</sup>  
O R I G I N A L

El programa de lealtad en dónde podrás ganar grandes premios por adquirir los mejores **productos CRP**.

¡Inscríbete hoy mismo en: [www.crpremios.com](http://www.crpremios.com)

(aplican términos y condiciones)



# MEISTERSATZ®

## O R I G I N A L

### Cuatro razones por las que **Meistersatz** es la mejor **Bomba de Agua** que pueda comprar

① **Sellos diseñados para soportar altas cargas de trabajo**

Componentes fabricados de acuerdo al vehículo y la especificación requerida por el fabricante.

Materiales compuestos de carburo y de silicón



Tecnología de punta en su fabricación ②

Elaboradas con equipo industrial de vanguardia tecnológica, con modernas líneas de producción.

③ **Calidad de Equipo Original**

Fabricadas con certificación ISO/TS16949, garantizando calidad en el producto

Impulsor de bomba (hélice) ④

Existen impulsores de bomba cerradas e impulsores de bomba abiertas, se emplean distintos materiales metálicos o plásticos altamente temporresistentes.



CONTITECH MEISTERSATZ PENTOSIN

© 2018 CRP de México S.A.de C.V.  
Todos los derechos reservados

**CRP de México SA de CV**

Ricardo Flores Magón 92 Bodega 7-9 Colonia San Jerónimo Caleras Puebla, Puebla, México C.P. 72100  
**Tel:** 01 2222 24.9056 **Lada sin costo:** 01 800 8382277  
**Email:** [mercadotecnia@crpindustries.com](mailto:mercadotecnia@crpindustries.com)  
**Web:** [www.meistersatz.com.mx](http://www.meistersatz.com.mx)